

# G6K(U)-2F(P)-RF(-S, -T)

Surface-mounting High-frequency Relay

## Surface-mounting, 1-GHz-Band/ 3-GHz-Band, Miniature, DPDT, High-frequency Relay

- Superior high-frequency characteristics (at 1 GHz), such as an isolation of 20 dB min. between contacts of the same polarity of 30 dB min. between contacts of different polarity with an insertion loss of 0.2 dB max.
- Miniaturized to 10.3 × 6.9 × 5.4 mm (L × W × H).
- Rated power consumption of 100 mW with high sensitivity
- Single-side stable and single-winding latching models are available.
- Models with a smaller footprint (G6K(U)-2F-RF-S) are available to help save space.
- G6K(U)-2F-RF-T models for 3-GHz band join the lineup with a downsized footprint.
- New PCB terminal models are available.

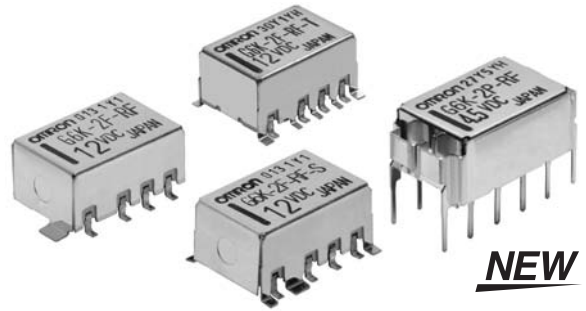

RoHS Compliant

### Model Number Legend

G6K□-□□-□-□  
1 2 3 4 5

#### 1. Relay Function

None: Single-side stable  
U: Single-winding latching

#### 2. Number of poles/ Contact Form

2: 2-pole/ DPDT (2c)

#### 3. Terminal Shape

F: Outside-L surface mounting terminals  
P: PCB terminals

#### 4. Special Function

RF: High-frequency compatible

#### 5. Terminal Shape

None: Standard  
S: Small footprint  
T: Compatible with 3 GHz

### Application Examples

- Communications equipment
- Broadcasting and audio-visual equipment
- Test & measurement equipment

G6K(U)-2F(P)-RF(-S, -T)

### Ordering Information

#### Standard Models with Surface-mounting Terminals Standard Specifications

Relay Function	Enclosure rating	Contact form	Model	Rated coil voltage	Minimum packing unit
Single-side stable	Fully sealed	DPDT (2c)	G6K-2F-RF	3, 4.5, 5, 12, 24 VDC	300 pcs/tray
Single-winding latching			G6KU-2F-RF		300 pcs/reel

#### Board space-saving model

Relay Function	Enclosure rating	Contact form	Model	Rated coil voltage	Minimum packing unit
Single-side stable	Fully sealed	DPDT (2c)	G6K-2F-RF-S	3, 4.5, 5, 12, 24 VDC	300 pcs/tray
Single-winding latching			G6KU-2F-RF-S		300 pcs/reel

#### Compatible with 3 GHz

Relay Function	Enclosure rating	Contact form	Model	Rated coil voltage	Minimum packing unit
Single-side stable	Fully sealed	DPDT (2c)	G6K-2F-RF-T	3, 4.5, 5, 12, 24 VDC	300 pcs/tray
Single-winding latching			G6KU-2F-RF-T		300 pcs/reel

#### PCB terminals

Relay Function	Enclosure rating	Contact form	Model	Rated coil voltage	Minimum packing unit
Single-side stable	Fully sealed	DPDT (2c)	G6K-2P-RF	3, 4.5, 5, 12, 24 VDC	30 pcs/tube

Note 1. When ordering, add the rated coil voltage to the model number.

Example: G6K-2F-RF DC3

Rated coil voltage

However, the notation of the coil voltage on the product case as well as on the packing will be marked as □□ VDC.

Note 2. When ordering Relays in tape packing, add "-TR03" to the end of the model number.

Example: G6K-2F-RF-TR03 DC3

Relays per reel: 300 pcs for -TR03

Be sure since "-TR" is not part of the relay model number, it is not marked on the relay case.

When ordering tape packing, minimum order unit is 1 reel (300 pcs × 1 = 300 pcs).

Note 3. Surface mounting terminal (SMT) standard models are shipped in moisture-proof package.

PCB terminal standard types do not require moisture proof packaging and therefore shipped in non-moisture-proof package.

## ■ Ratings

### ● Coil: Single-side Stable (G6K-2F(P)-RF(-S, -T))

Rated voltage	Item	Rated current (mA)	Coil resistance (Ω)	Must operate voltage (V)	Must release voltage (V)	Maximum voltage (V)	Power consumption (mW)
				% of rated voltage			
3 VDC		33.0	91	80% max.	10% min.	150%	Approx. 100
4.5 VDC		23.2	194				
5 VDC		21.1	237				
12 VDC		9.1	1,315				
24 VDC		4.6	5,220				

### ● Coil: Single-winding Latching Models (G6KU-2F-RF(-S, -T))

Rated voltage	Item	Rated current (mA)	Coil resistance (Ω)	Must set voltage (V)	Must reset voltage (V)	Maximum voltage (V)	Power consumption (mW)
				% of rated voltage			
3 VDC		33.0	91	75% max.	75% max.	150%	Approx. 100
4.5 VDC		23.2	194				
5 VDC		21.1	237				
12 VDC		9.1	1,315				
24 VDC		4.6	5,220				

Note 1. The rated current and coil resistance are measured at a coil temperature of 23°C with a tolerance of ±10%.

Note 2. The operating characteristics are measured at a coil temperature of 23°C.

Note 3. The maximum voltage is the highest voltage that can be imposed on the Relay coil instantaneously.

### ● Contacts

Item	Load	Resistive load
Rated load		125 VAC, 0.3 A 30 VDC, 1 A 1 GHz, 1 W *
Rated carry current		1 A
Max. switching voltage		125 VAC or 60 VDC
Max. switching current		1A

\* This value is for a V.SWR of 1.2 max. at the load.

### ● High-frequency Characteristics \*1

Item	Model Frequency	G6K(U)-2F(P)-RF(-S)		G6K(U)-2F-RF-T	
		1GHz	1GHz	3GHz	3GHz
Isolation	Between contacts of the same polarity	20 dB min.	20 dB min.	18 dB min.	
	Between contacts of different polarity	30 dB min.	30 dB min.	25 dB min.	
Insertion loss		0.2 dB max.	0.2 dB max.	0.6 dB max.	
V.SWR		1.2 max.	1.2 max.	1.4 max.	
Maximum carry power		3W *2			
Maximum switching power		1W *2			

Note 1. The impedance of the measurement system is 50 Ω.

Note 2. The above values are initial values.

\*1. Contact your OMRON representative if the Relay will be used in an application that requires high repeatability in high-frequency characteristics for the microload region. (Such applications include testing and measurement equipment and ATE applications.)

\*2. These values are for a V.SWR of 1.2 max. at the load.

## ■ Characteristics

Item	Relay Function Model	Single-side stable models	Single-winding latching models
		G6K-2F(P)-RF(-S, -T)	G6KU-2F-RF(-S, -T)
Contact resistance *1		100 mΩ max.	
Operating (set) time *2		3 ms max. (approx. 1.4 ms)	3 ms max. (approx. 1.2 ms)
Release (reset) time *2		3 ms max. (approx. 1.3 ms)	3 ms max. (approx. 1.2 ms)
Minimum set/reset pulse time		---	10 ms
Insulation resistance *3		1,000 MΩ min. (at 500 VDC)	
Dielectric strength	Between coil and contacts	750 VAC, 50/60 Hz for 1 min	
	Between contacts of different polarity	750 VAC, 50/60 Hz for 1 min	
	Between contacts of the same polarity	750 VAC, 50/60 Hz for 1 min	
	Between ground and coil/contacts	500 VAC, 50/60 Hz for 1 min	
Vibration resistance	Destruction	10 to 55 to 10 Hz, 2.5 mm single amplitude (5 mm double amplitude) and 55 to 500 Hz, 300 m/s <sup>2</sup>	
	Malfunction	10 to 55 to 10 Hz, 1.65 mm single amplitude (3.3 mm double amplitude) and 55 to 500 Hz, 200 m/s <sup>2</sup>	
Shock resistance	Destruction	1,000 m/s <sup>2</sup>	
	Malfunction	750 m/s <sup>2</sup>	
Durability	Mechanical	50,000,000 operations min. (at a switching frequency of 36,000 operations/hour)	
	Electrical	100,000 operations min. (at a switching frequency of 1,800 operations/hour)	
Ambient operating temperature		-40°C to 70°C (with no icing or condensation)	
Ambient operating humidity		5% to 85%	
Weight		Approx. 0.95 g	

Note. The above values are initial values.

\*1. The contact resistance was measured with 10 mA at 1 VDC with a voltage drop method.

\*2. Values in parentheses are actual values.

\*3. The insulation resistance was measured with a 500 VDC megohmmeter applied to the same parts as those used for checking the dielectric strength.

# G6K(U)-2F(P)-RF(-S, -T)

# Surface-mounting High-frequency Relay

## Engineering Data



### High-frequency Characteristics (Isolation) \*1, \*2

G6K-2F-RF



### High-frequency Characteristics (Insertion Loss) \*1, \*2

G6K-2F-RF



### High-frequency Characteristics (Return Loss, V.SWR) \*1, \*2

G6K-2F-RF

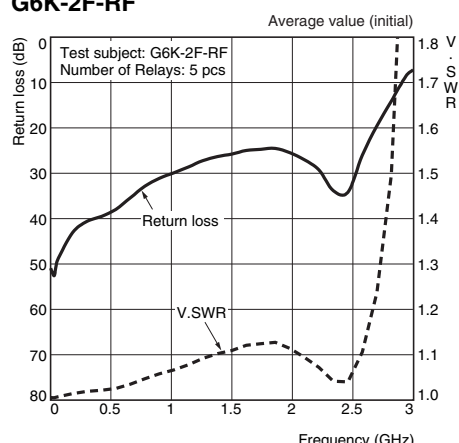

G6K-2F-RF-S



G6K-2F-RF-S



G6K-2F-RF-S

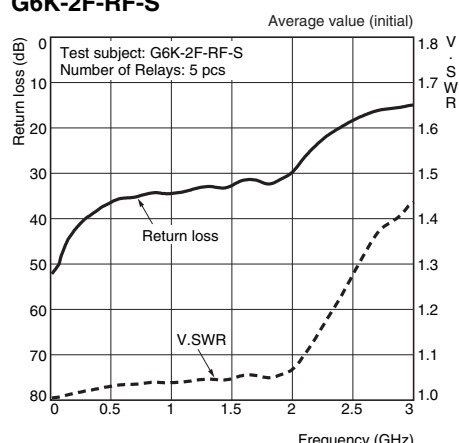

G6K-2F-RF-T



G6K-2F-RF-T



G6K-2F-RF-T

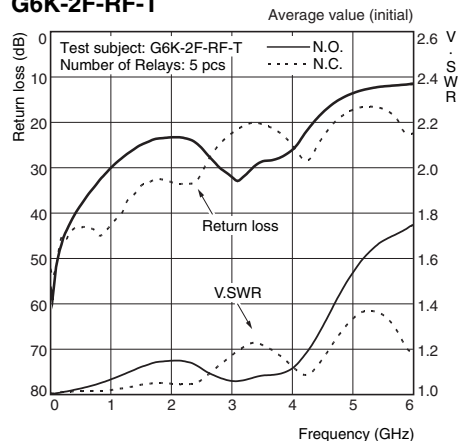

G6K(U)-2F(P)-RF(-S, -T)

# G6K(U)-2F(P)-RF(-S, -T)

# Surface-mounting High-frequency Relay

## G6K-2P-RF

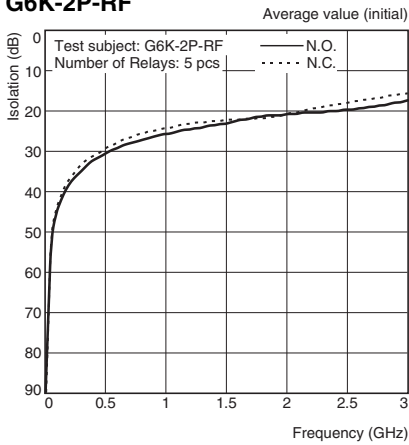

## G6K-2P-RF



## G6K-2P-RF



Note. Refer to the G6K specifications for basic specifications not shown above.

\*1. Ambient temperature condition: 23°C

\*2. The high-frequency characteristics depend on the mounting board.

Be sure to check operation including durability in actual equipment before use.

## Dimensions

(Unit: mm)

### Standard Specifications

G6K-2F-RF  
G6KU-2F-RF



### Mounting Dimensions (Top View)

Tolerance:  $\pm 0.1$  mm

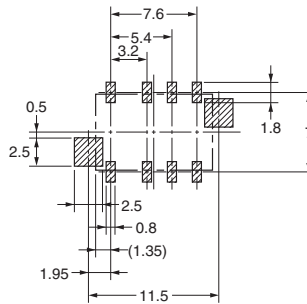

### Terminal Arrangement/ Internal Connections (Top View)

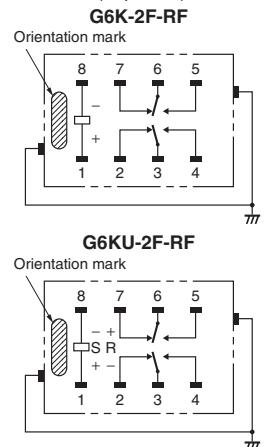

Note 1. Each value has a tolerance of  $\pm 0.3$  mm.

Note 2. The coplanarity of the terminals is 0.15 mm max.

Note: Check carefully the coil polarity of the Relay.

### Board space-saving model

G6K-2F-RF-S  
G6KU-2F-RF-S

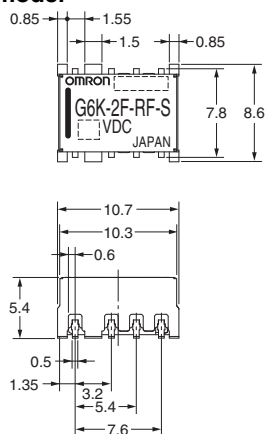

### Mounting Dimensions (Top View)

Tolerance:  $\pm 0.1$  mm

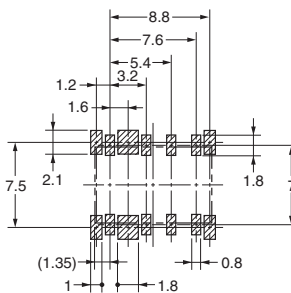

### Terminal Arrangement/ Internal Connections (Top View)

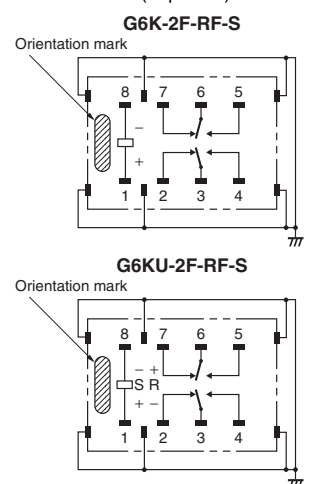

Note 1. Each value has a tolerance of  $\pm 0.3$  mm.

Note 2. The coplanarity of the terminals is 0.15 mm max.

Note: Check carefully the coil polarity of the Relay.

# G6K(U)-2F(P)-RF(-S, -T)

## Surface-mounting High-frequency Relay

Compatible with 3 GHz

G6K-2F-RF-T  
G6KU-2F-RF-T

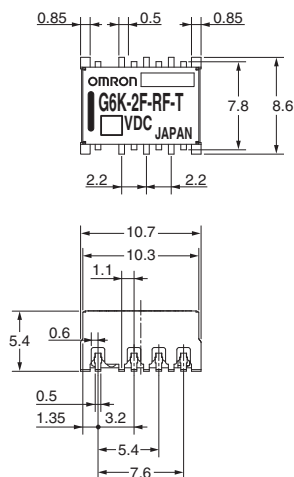
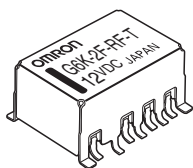

Mounting Dimensions (Top View)

Tolerance:  $\pm 0.1$  mm

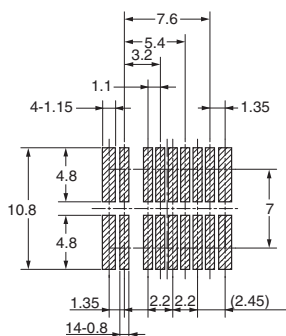

PCB information

Layer Structure: 2L

Finished Thickness: 0.6 mm

Copper Thickness: 18  $\mu$ m

Terminal Arrangement/  
Internal Connections  
(Top View)

G6K-2F-RF-T

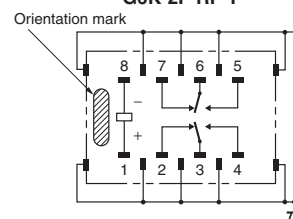

G6KU-2F-RF-T

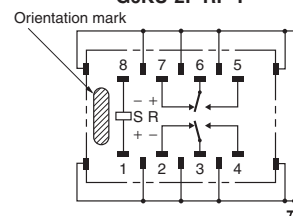

- Note 1. Each value has a tolerance of  $\pm 0.3$  mm.  
 Note 2. The coplanarity of the terminals is 0.15 mm max.  
 Note 3. The board dimensions are the dimensions that were used to measure the high-frequency characteristics given in the engineering data.  
 The high-frequency characteristics and soldering conditions will depend on the type of board that is actually used. Always confirm applicability with the actual equipment before you use the Relay.

Note: Check carefully the coil polarity of the Relay.

PCB terminals

G6K-2P-RF

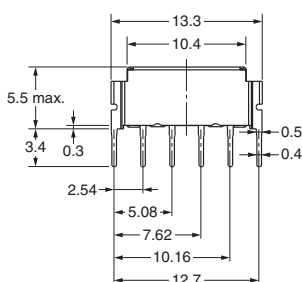
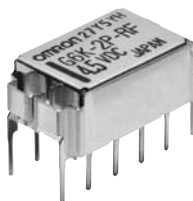

PCB Mounting Holes (Bottom View)

Tolerance:  $\pm 0.1$  mm

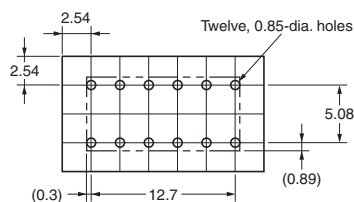

Terminal Arrangement/  
Internal Connections  
(Bottom View)

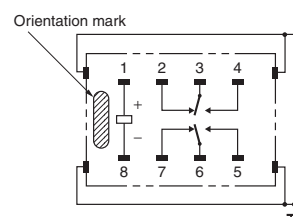

Note. Each value has a tolerance of  $\pm 0.3$  mm.

Note: Check carefully the coil polarity of the Relay.

G6K(U)-2F(P)-RF(-S, -T)

## Tube Packing and Tape Packing Specifications

Surface mounting terminal (SMT) standard models are shipped in moisture-proof package, and PCB terminal standard types do not require moisture proof packaging and therefore shipped in non-moisture-proof package.

Please refer to "Correct Use" for handling after opening moisture-proof packaging for Surface mounting terminal (SMT) models.

### (1) Tube Packing

- G6K-2P-RF in tube packing are arranged so that the orientation mark of each Relay in on the left side. Fifty Relays are packed on one tube.

Be sure not to make mistakes in Relay orientation when mounting the Relay to the PCB.

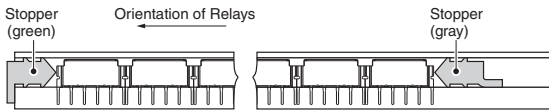

Tube length: 520 mm (stopper not included)

No. of Relays per tube: 30 pcs

### (2) Tape Packing (Surface Mounting Terminal Models)

- Add "TR03" to the end of the model number to order Relays in tape packing.

If "-TR03" is not added, the Relays will be provided in tray packing.

Relays per reel: 300 pcs

Minimum ordering unit: 1 reel (300 relays)

#### 1. Direction of Relay Insertion

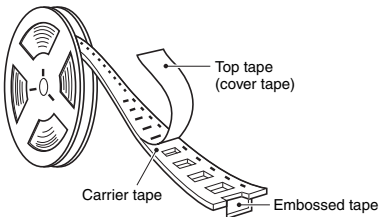

#### Pulling Direction

G6K(U)-2F-RF

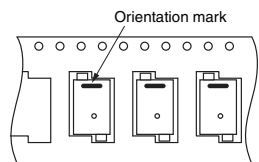

G6K(U)-2F-RF-S(-T)

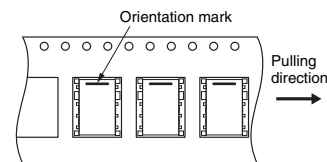

#### 2. Reel Dimensions

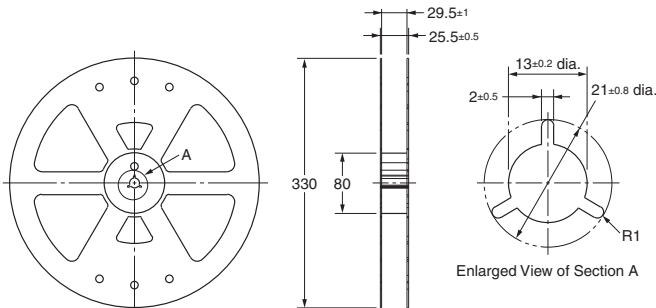

### 3. Carrier Tape Dimensions

G6K(U)-2F-RF

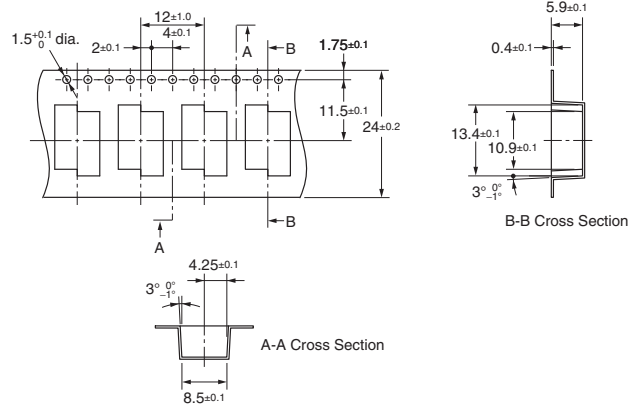

G6K(U)-2F-RF-S(-T)

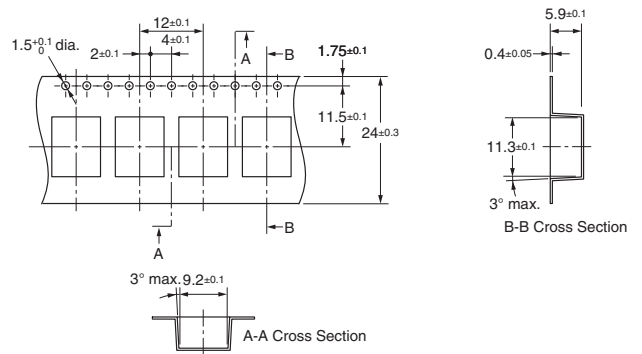

## ■G6K(U)-2F-RF(-S, -T) Recommended Soldering Method

### ●Recommended Conditions for IRS Method (Surface-mounting Terminals)

#### (1) IRS Method (Mounting Solder: Lead)



(The temperature profile indicates the temperature on the circuit board sur-

#### (2) IRS Method (Mounting Solder: Lead-free)



(The temperature profile indicates the temperature on the PCB.)

- The thickness of cream solder to be applied should be between 200 and 250  $\mu\text{m}$  and the land pattern should be based on OMRON's recommended PCB pattern.
- To maintain the correct soldering joint shown in the following diagram, we recommend applying solder with the soldering conditions shown on the left.

#### Correct Soldering



#### Incorrect Soldering



Check the soldering in the actual mounting conditions before use.

## ■ Safety Precautions

- For general precautions on PCB Relays, refer to the precautions provided in General Information of the Relay Product Data Book.

### Correct Use

#### ● Relay Handling

- Use the Relay as soon as possible after opening the moistureproof package. (As a guideline, use the Relay within one week at 30°C or less and 60% RH or less.) If the Relay is left for a long time after opening the moisture-proof package, the appearance may suffer and seal failure may occur after the solder mounting process. To store the Relay after opening the moisture-proof package, place it into the original package and seal the package with adhesive tape.
- When washing the product after soldering the Relay to a PCB, use a water-based solvent or alcohol-based solvent and keep the solvent temperature to less than 40°C. Do not put the Relay in a cold cleaning bath immediately after soldering.

#### ● Environmental Conditions for Usage, Storage, and Transport

- Avoid direct sunlight when using, storing, or transporting the Relay and maintain normal temperature, humidity, and pressure conditions.

#### ● Long-term, Continuous ON Contacts

- Using the Relay in a circuit where the Relay will be ON continuously for long periods (rather than switching) can lead to unstable contacts because the heat generated by the coil itself will affect the insulation and can cause a film to develop on the contact surfaces. We recommend using a latching relay (magnetic-holding relay) in this kind of circuit. If a single-side stable model must be used in this kind of circuit, we recommend adding fail-safe circuits in case the contact fails or the coil burns out.

#### ● Claw Securing Force During Automatic Mounting

- During automatic insertion of Relays, be sure to set the securing force of each claw to the following so that the Relay's characteristics will be maintained.



Direction A: 1.96 N max.  
 Direction B: 4.90 N max.  
 Direction C: 1.96 N max.

- Secure the claws to the shaded area. Do not attach them to the center of the Relay or just one part of the Relay.

#### ● Coating

- Do not use silicone coating to coat the Relay when it is mounted to the PCB. Do not wash the PCB after the Relay is mounted using detergent containing silicone. Otherwise, the detergent may remain on the surface of the Relay.

#### ● Repeatability

- Contact your OMRON representative if the Relay will be used in an application that requires high repeatability in high-frequency characteristics for the microload region. (Such applications include testing and measurement equipment and ATE applications.)

#### ● About use of an IC socket.

##### For: G6K-2P-RF

- When using IC sockets, select IC sockets by confirming that the sockets Rated/Spec./Characteristics are within the range of using condition. Also, confirm whether there is any problem of electric capability or plug insertion or not with actual using condition.

#### ● Others

##### For: G6K-2P-RF

- The dotted line below on the surface of relay is connected with a metal case (ground). So confirm the actual influence of insulation and signal characteristics when designing.

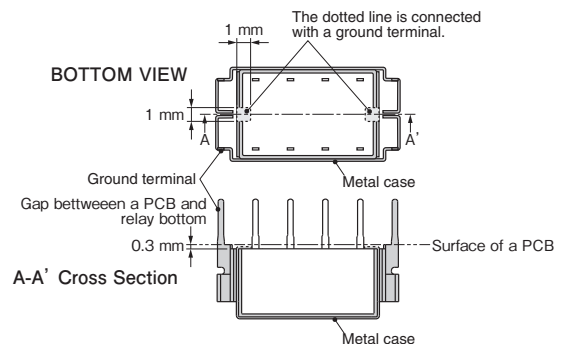

• Application examples provided in this document are for reference only. In actual applications, confirm equipment functions and safety before using the product.  
 • Consult your OMRON representative before using the product under conditions which are not described in the manual or applying the product to nuclear control systems, railroad systems, aviation systems, vehicles, combustion systems, medical equipment, amusement machines, safety equipment, and other systems or equipment that may have a serious influence on lives and property if used improperly. Make sure that the ratings and performance characteristics of the product provide a margin of safety for the system or equipment, and be sure to provide the system or equipment with double safety mechanisms.

**Note: Do not use this document to operate the Unit.**